

INSULATION JUST GOT COOLER

ArmaGel[®] DT

Flexible aerogel insulation blanket for
cryogenic and dual-temperature applications

Application Manual

www.armacell.com/armagel

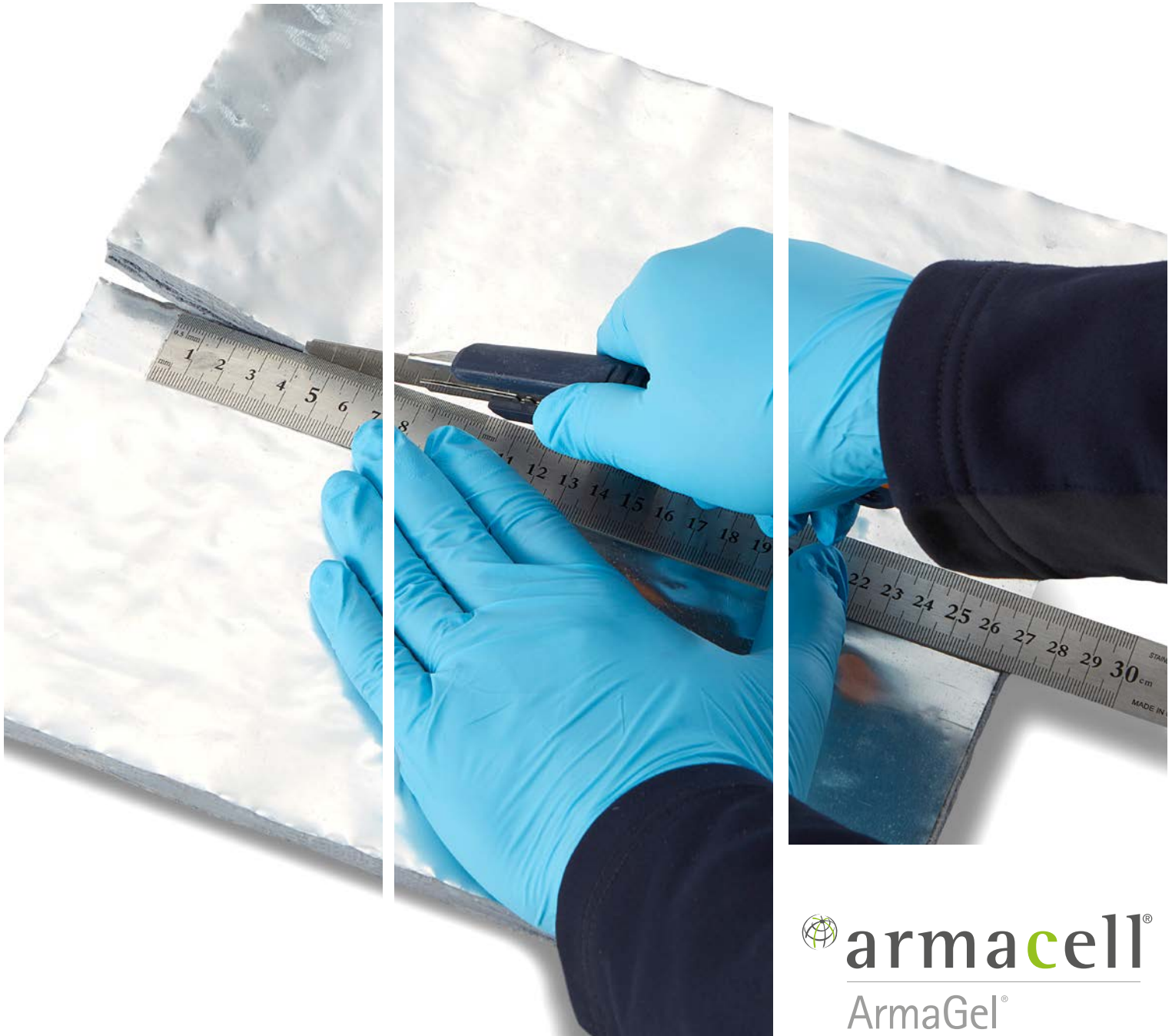

 **armacell**[®]
ArmaGel[®]



Dual-
temperature

About ArmaGel DT

Welcome to the next generation of aerogel insulation technology. Flexible and bendable.

Environmentally safe. Superior thermal performance. Cryogenic conditions down to $-180\text{ }^{\circ}\text{C}$ ($-292\text{ }^{\circ}\text{F}$).

ArmaGel DT is the reliable solution for cryogenic and dual-temperature applications.

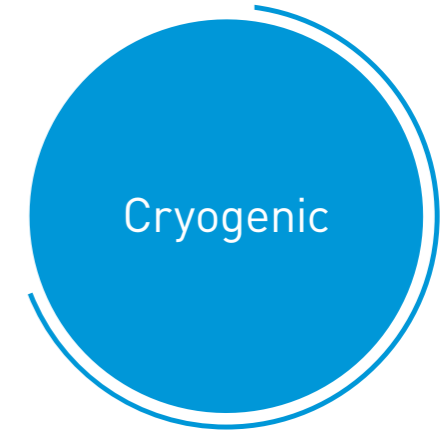

CONTENT

04

PREPARATION

- 04 Before you start
- 05 Preparation
- 06 Site Requirements

07

APPLICATION DETAILS

- 07 Insulating straight pipe – single layer
- 09 Insulating straight pipe – multi-layer
- 10 Vapour stop application
- 11 Piping fitting – segmented bend
- 13 Piping fitting – Equal Tee
- 16 Protrusions
- 18 End caps
- 19 Valve Body
- 22 Valve Spindle
- 24 Vapour Stop of Valve
- 26 Vapour Seal - rigid pipe supports/ insulation transition
- 27 Primary vapour barrier - straights
- 29 Primary vapour barrier - bend
- 31 Primary vapour barrier - Equal Tee

29

APPENDIX

- 33 Hot insulation
- 34 Dual-temperature insulation
- 35 Jacketing and finishing
- 36 Insulation and accessory list

Before you start

Personal protective equipment (PPE) and safety considerations: ArmaGel DT will produce some amounts of dust particles - for your comfort some PPE measures are recommended.

Working with ArmaGel DT



Figure 1:
Personal protective equipment

ArmaGel DT will produce some amounts of dust and fibers during handling and cutting which must be managed in accordance with local regulations. See ArmaGel safety data sheet at www.armacell.com/armagel.

For worker comfort we recommend the PPE shown above.

Material Handling and storage

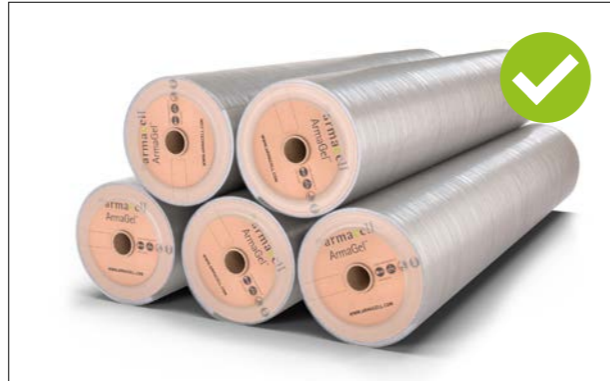

Figure 2:
Correct storage conditions

ArmaGel DT rolls must always be laid / stacked sideways, never on end and always stored under cover and in dry conditions.

Preparation

- Retractable craft (Stanley) type knife
- Ceramic knife
- Electric / battery operated shears
- Heavy duty scissors
- Straight edge
- Set square
- Dividers and calipers
- Tape measure
- Marker pens
- Pliers

Prefabrication and Preparation in the Workshop



Figure 3:
Prefabrication cutting in the workshop



Figure 5:
Prefabricated parts ready to transport to jobsite

Prefabricated parts for straights and fittings can be prepared and palletised. Protect from adverse weather.



Figure 4:
Recommended tools for application of ArmaGel DT

Simple tools are required for measuring, marking and cutting.



Note

Within workshop locations, as part of good housekeeping, the use of an industrial type vacuum for cleaning aerogel dust is recommended.

Site requirements

Ensure that the jobsite conditions are optimal. Protect the insulation from adverse weather.

Weather and Equipment Conditions



Figure 6:
Ensure that piping is clean, dry and free from ice

Enclosures / tenting may be required if rain or bad weather is expected during installation. Do not install ArmaGel DT if weather conditions are unsuitable (eg. rain, condensing fog, snowfall, ...).

Application Details

Insulating Straight Pipe – Single Layer application



Figure 7:
Determining the circumference of the pipe

Using a thin strip of ArmaGel DT, determine the actual outer circumference of the pipe. This will provide the actual cutting size required to perform a complete wrap around the pipe.



Figure 8:
Application of filament tape

Wrap the prepared section of material around the pipe making sure that it maintains a close fit all the way around. ArmaGel DT can be held in place by using filament tape. The tape can be applied at 200-300mm centres depending on pipe size.

Ensure no gaps are present in the insulation between all the longitudinal and circumference butt joint connections.

When an overlap is applied, it is recommended to position this pointing downward in order to create a watershed.

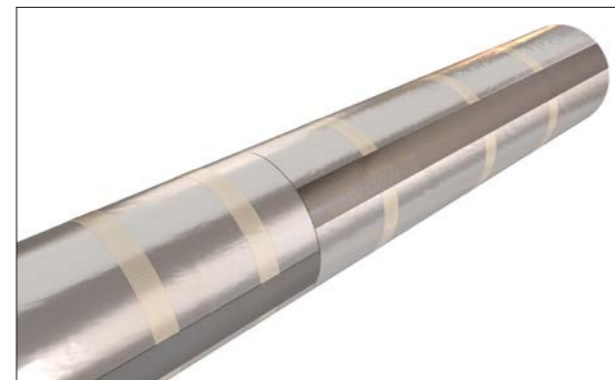

Figure 9:
Application of vapour barrier tape on a longitudinal joint

Clean the foil surface with a clean dry cloth before applying the vapour barrier tape to the seams and joints.

Apply 75mm -100mm wide vapour barrier tape over the longitudinal and circumferential seams and joints.

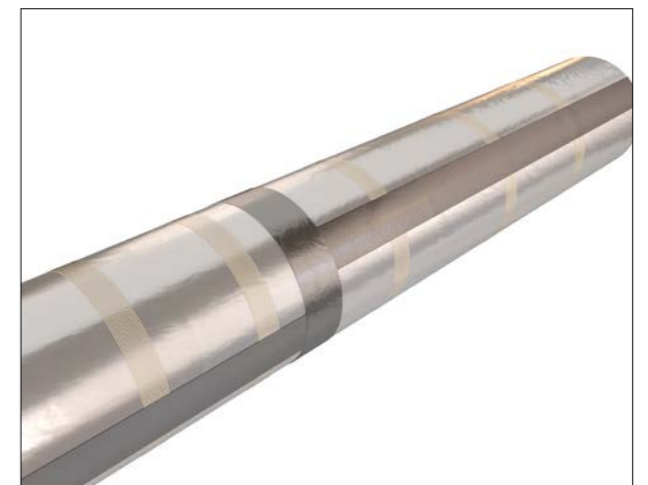

Figure 10:
Application of vapour barrier tape on a circumferential joint



Note

If required an overlap can be added.

Application Details

Insulating Straight Pipe – Single Layer application (continued)

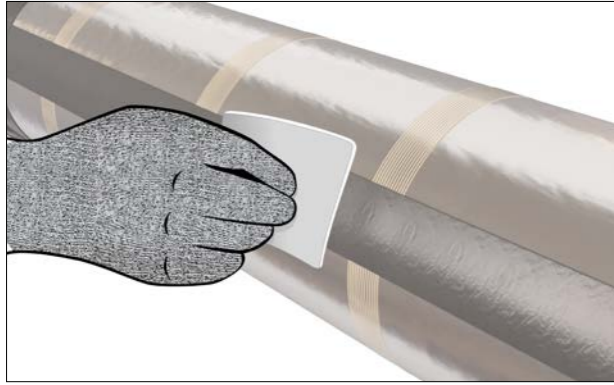

Figure 11:
Using a tape card

Apply firm even pressure using a tape card ensuring the vapour barrier tape and its edges are fully adhered to the outer surface of the foil covered ArmaGel DT.

Application Details

Insulating Straight Pipe - Multi-layer



Figure 12:
Determining the circumference of insulation for multi-layering

For multi-layer applications, follow the same process as with the 1st layer, ensuring that the circumference of the insulation on each subsequent layer is correctly measured each time with a new strip of material. See the straight piping section for details.

Ensure all the longitudinal and circumferential joints are butted tightly together with no gaps.

Stagger all seams and joints on all insulation layers at least 100mm in all directions.

When an overlap is applied on the outmost layer, it is recommended to position the overlap with downward facing watershed.

Table 1: Recommended minimum pipe size for various ArmaGel DT blanket thickness on straight piping.

Pipe Size: NB (INCH) (mm)	ArmaGel DT Insulation Blanket Thickness (mm)			
	5	10	15	20
1 (35)	✓	✗	✗	✗
2 (60)	✓	✓	✗	✗
3 (89)	✓	✓	✓	✗
4 (114)	✓	✓	✓	✓
5 (140)	✓	✓	✓	✓
6 (169)	✓	✓	✓	✓
8 (219)	✓	✓	✓	✓
10 & Above	✓	✓	✓	✓

Notes:

- ✓ Indicates blanket thickness that can be used when bending round a given pipe size.
- ✗ not recommend.
- Outer diameter (mm) of pipe size can also be used for the outer diameter of a flanged fitting when applying ArmaGel DT.

Application Details

Vapour Stop Application



Figure 13:
Application of vapour stop at insulation termination

Apply the vapour stop coating with a brush, trowel or manufacturers' recommended tool to the outer insulated surface of ArmaGel DT and pipe surface as shown. The vapour stop should extend at least 50-100mm along ArmaGel DT and the pipe surface from the end termination of ArmaGel DT.

Ensure both surfaces have consistent film thickness coverage.

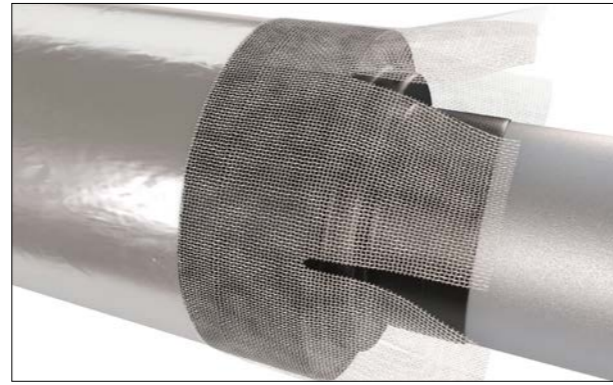

Figure 14:
Feathering of flexible reinforcement membrane (50mm sections)

Determine the size of the flexible reinforcement membrane required to cover the coated area which provides a minimum of 100mm overlap around the circumference of the insulation.

Embed the flexible reinforcement membrane into the insulation termination with a paintbrush and / or spatula.

The flexible reinforcement membrane is feathered into 50mm wide sections depending on pipe size and embedded into the coating as shown.



Figure 15:
Application of vapour stop

Allow vapour stop coating to become touch dry before applying the next coat. Continue to apply additional coats until the vapour stop has reached a film thickness specified by the manufacturer.



Note

At insulation terminations next to flanged fittings, as well as all protruding pipe connections, a vapour stop coating is required in combination with an industry standard flexible reinforcement membrane. The vapour stop is applied in multiple coats to achieve a film thickness according to the manufacturer's recommendations.

Application Details

Piping Fitting – Segmented Bend



Figure 16:
Fabrication of fish-tail patterns

Fabricate the appropriate fish-tail pattern from metal sheet.

With a sharp knife cut the appropriate number of segments from the prefabricated metal sheet pattern to fit the bend.



Figure 18:
Segment installation

Apply the centre segments around the bend fittings, and finish with final segment (finisher) as shown in the photo. Secure all segments in place with the filament tape. Ensure all seams and joints are tightly butted.

Clean the surface of the segments with a clean cloth before applying the vapour barrier tape.



Note

Final adjustments to the segments can be performed by twisting the segments carefully before applying vapour barrier tape to the seams and joints.



Figure 17:
Application of starter segment

Apply the 1st segment (starter) up to the weld of the bend fitting.

Apply the filament tape to secure the segment in place. Ensure the seam is tightly butted with no gaps.

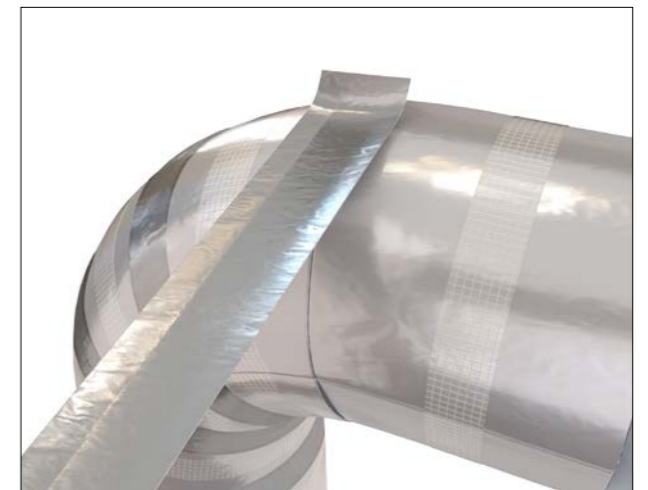

Figure 19:
Application of vapour barrier tape

Apply 75mm wide vapour barrier tape to all the seams and joints on all the segments of the elbow.

For bigger pipe sizes 100mm wide vapour barrier tape can be used.

Application Details

Piping Fitting – Segmented Bend (continued)



Figure 20:
Fully secured vapour barrier tape

Apply firm even pressure using a tape card or with fingers, ensuring that the vapour barrier tape and its edges are fully secured to the surface of the foil covered ArmaGel DT.

Application Details

Piping Fitting (Equal Tee) – 2 part construction



Figure 21:
Measure circumference of pipe

As with the instructions for insulating straight pipe, measure the outer circumference of the tee with a thin strip of ArmaGel DT.

Measure the un-insulated outer diameter of the pipe.



Figure 23:
Securing insulation layer with filament tape

Apply the insulation tightly around the pipe and secure each side of the tee connection with filament tape.

Ensure the seams are tightly butted with no gaps.



Figure 22:
Equal tee fabrication

Cut the insulation to the required size, circumference and length of the tee fitting. An allowance for an overlap can be provided if required.

Make the cut outs for the diameter of the bare pipe tee.

For repeated fabrication, a metal template can be produced.

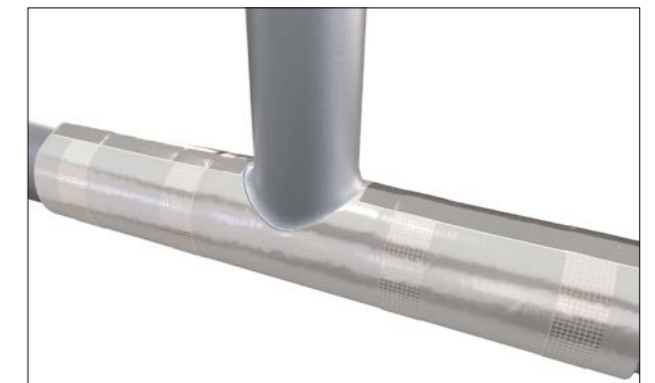

Figure 24:
Securing equal tee with vapour barrier tape

Clean the outer surface of the material with a clean dry cloth and apply 75mm wide vapour barrier tape along the linear seam.

Follow all procedures for the fixing and securing of the vapour barrier tape to the surface of the insulation.

Application Details

Piping Fitting (Equal Tee) – 2 part construction (continued)

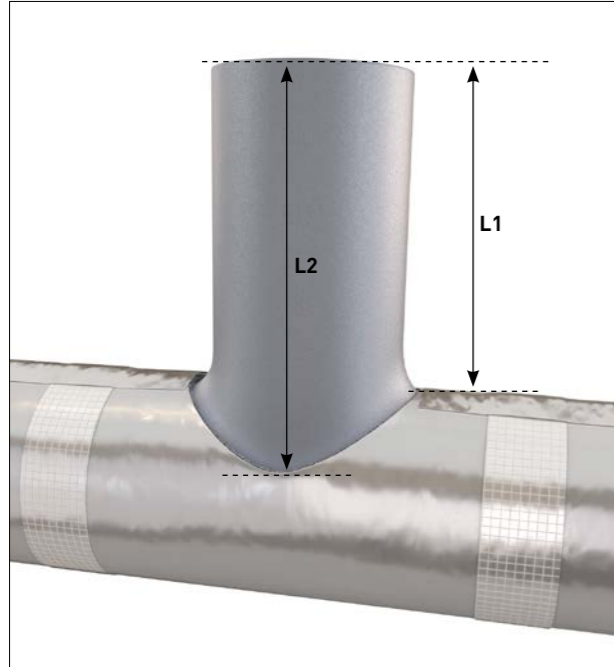

Figure 25:
Determining the height of tee piece

Use the lengths L1 & L2 to create the size and shape of the required tee piece. Metal templates can be fabricated when preparing multiple tee pieces.



Figure 26:
Tee piece fitting cover

Cut out the tee piece fitting cover and clean any dust from the foil surface with a clean cloth.

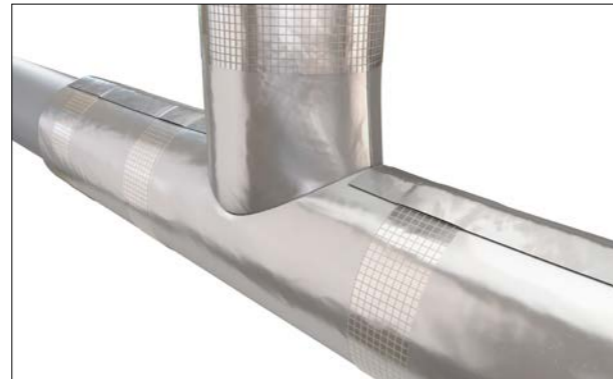

Figure 27:
Application of tee piece fitting cover

Fix and secure the tee fitting cover with filament tape. Ensure all the seams and joints are tightly butted with no gaps.

Application Details

Piping Fitting (Equal Tee) – 2 part construction (continued)



Figure 28:
Application of vapour barrier tape

Using a clean cloth, clean and remove any dust from the surfaces where the vapour barrier tape is to be installed.

Seal all the seams and joints with the vapour barrier tape.



Figure 29:
Securing vapour barrier tape

With firm pressure using a tape card or fingers, smoothen the vapour barrier tape following the contours of the tee connection, making sure the vapour barrier tape is fully secured down to the insulation surface.

Application Details

Protrusions



Figure 30:
Insulating a protrusion

Insulate the protrusion as per the insulation specification or to a minimum length of 3 times the insulation thickness of connecting pipe or equipment.

Vapor seal all seams and joints with the appropriate vapour barrier tape.



Figure 31:
Application of vapour stop

Apply a thick layer of the vapour stop coating to the protrusion and the connecting insulated pipe surface which extends 100mm either side of the protrusion.

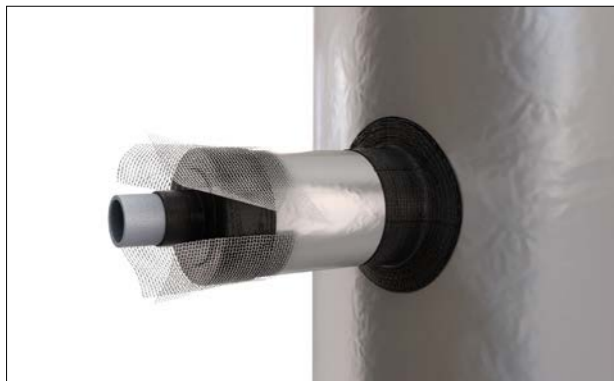

Figure 32:
Application of flexible reinforcement membrane

Cut the flexible reinforcement membrane to the applicable size and feather to enable the membrane to cover the protrusion and the termination insulation end.

The reinforcement membrane should have a minimum circumferential overlap of 100mm and extend onto the pipe surface by a minimum of 50mm.



Figure 33:
Embed the flexible reinforcement membrane into the vapour stop

Embed the flexible reinforcement membrane into the vapour stop coating with a brush, then apply a reinforcement membrane strip over the feathered section connecting to the pipe surface.

Application Details

Protrusions (continued)



Figure 34:
Application of vapour stop

Allow the vapour stop coating to become touch dry before applying additional coats. Continue to apply additional coats until the vapour stop has reached a film thickness specified by the manufacturer.



Note

It is recommended to insulate the protrusion following project insulation specification.

Application Details

End Caps



Figure 35:
Application of end disc

Cut out an end disc equal to the outer diameter of the pipe end cap. The total thickness build-up of the disc shall be the same as the thickness of connecting insulation.

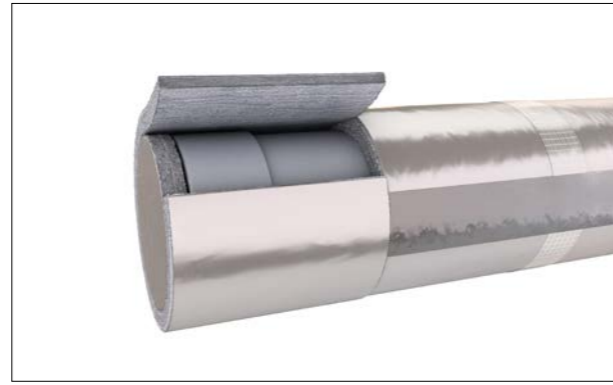

Figure 36:
Insulating an end cap

Cut a piece of insulation to fit the length and circumference of the pipe and end cap.



Figure 37:
Securing end cap with filament tape and vapour barrier tape

Wrap the insulation around the pipe and secure with filament tape.

Ensure all seams are tightly butted with no gaps. Seal all seams and joints including the end cap end with the vapour barrier tape.

Application Details

Valve Body



Figure 38:
Packing pipe void

For the preparation for insulating a valve body, allow the vapour stop at insulation terminations to become completely dry.

Pack out the bare pipe voids between the insulation connection and the valve flange ends plus the valve body cavity with strips of loose fill ArmaGel DT.

Secure the loose fill strips with filament tape.



Figure 40:
Valve body cut out

Determine the size of cut-out required for any valve spindle or connections protruding from the valve body.

Remove the required cut out from the valve body insulation cover. Clean any dust from surface with a clean, dry cloth.



Figure 39:
Insulating valve body

Determine the required length of the valve body insulation cover. The length of the insulation cover should extend at least 100mm either side of the pipe end terminations or in accordance with the project specifications.



Figure 41:
Securing valve body cover with filament tape

Wrap ArmaGel DT around the valve body and secure with filament tape.

Ensure all seams and joints are tightly butted with no gaps.

Application Details

Valve Body (continued)



Figure 42:
Application of vapour barrier tape

Clean the ArmaGel DT surface and vapour seal all seams and joints with the vapour barrier tape.



Figure 43:
Application of vapour barrier tape at termination

Seal the termination ends of the valve body with strips of vapour barrier tape to the outer surfaces of the terminations and the connecting insulated piping surfaces.

Application Details

Valve Body (continued)



Figure 46:
Completely sealed termination

Complete the sealing of termination end using vapour barrier tape.

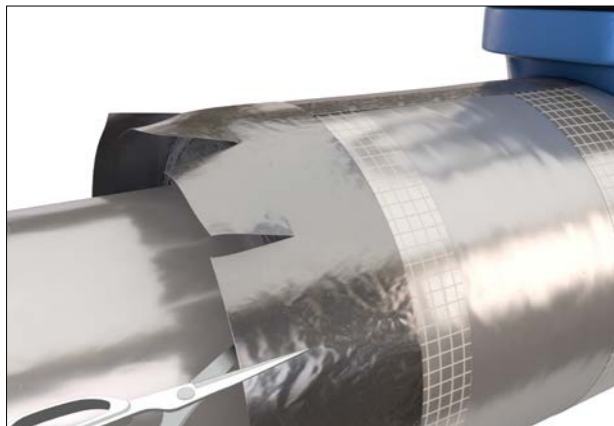

Figure 44:
Cutting and feathering the vapour barrier tape

The vapour barrier tape is cut and feathered as required and secured down to the surface of the insulated pipe connections.

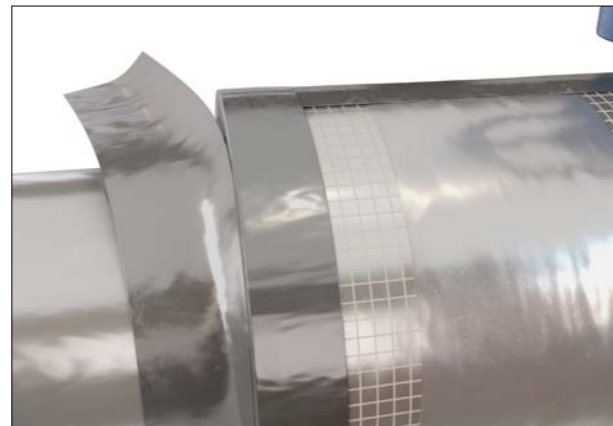

Figure 45:
Application of vapour barrier tape at termination

Apply a strip of vapour barrier tape over the feathered connections. Additional strips of vapour barrier tape can be used to seal the connections when needed.

Application Details

Valve Spindle

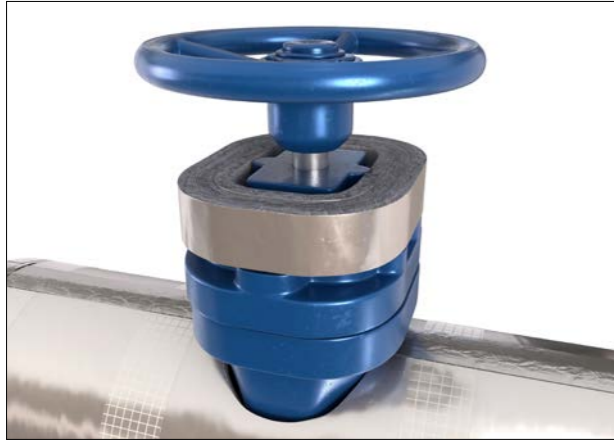

Figure 47:
Pack out spindle cavity

With thin strips of ArmaGel DT, pack out the spindle cavity to the required height as recommended by valve manufacturers or project specification. The thickness of the packing should equal the depth of the flanged spindle fitting.

Build up the insulation thickness to be same level with the flanged spindle fitting connection.

Determine the circumference of the flanged spindle fitting with a strip of ArmaGel DT.



Figure 49:
Secure fitting cover with filament tape

Wrap the fitting cover around the spindle and secure with filament tape. Clean the surface of ArmaGel DT with a clean, dry cloth and seal all seams and joints with the vapour barrier tape.



Figure 48:
Fabricating the insulation for valve connection

Cut out the applicable insulation material to suit the shape required for the connection – Similar to a tee connection.



Figure 50:
Insulate the top of valve spindle

Insulate of the exposed layers of insulation at the top of the insulation cover with a bespoke disc of ArmaGel DT to complete the installation. Do not insulate over any maintenance or moving parts contained within the spindle mechanism.

Application Details

Valve Spindle (continued)

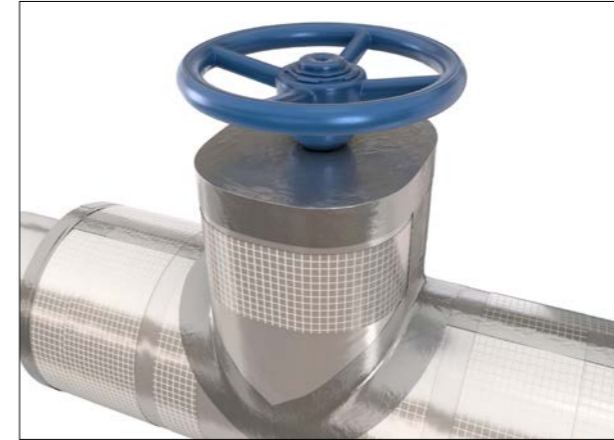

Figure 51:
Application of vapour barrier tape at all joints and seams

Using a clean, dry cloth, clean and remove any dust from the surface of ArmaGel DT.

Seal all seams and joints with vapour barrier tapes.



Note

Ensure there is no gap between the insulation joints and seams before sealing with vapour barrier tapes.

Application Details

Vapour Stop of Valve



Figure 52:
Clean, dry and dust free surface

Apply primary vapour barrier over the final layer of ArmaGel DT. Ensure the surface of primary vapour barrier is clean and dry before applying the vapour stop. Remove all dust from the surface with a clean and dry cloth.



Figure 53:
Application of vapour stop

Apply the vapour stop onto the outer surfaces of the terminations and the surfaces of the connecting insulated piping.

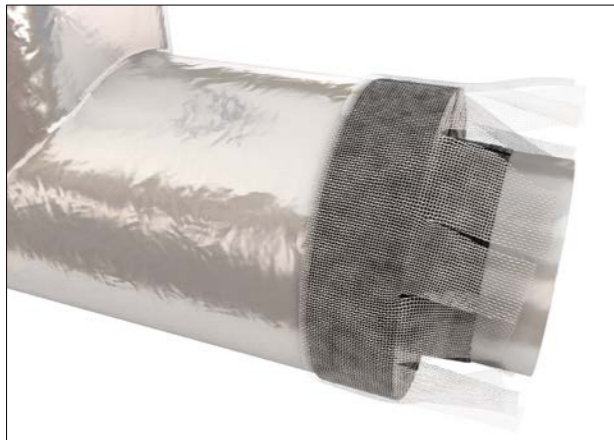

Figure 54:
Application of flexible reinforcement membrane

Pre-fabricate the flexible reinforcement membrane. Follow the procedures as indicated in the section for "Vapour Stop at Pipe Application".

Allow vapour stop coating to touch dry before applying additional coats. Continue to apply additional coats until the vapour stop has reached a film thickness specified by the manufacturer.



Figure 55:
Application of vapour stop at valve spindle

Apply the vapour stop onto the termination end of the spindle insulation cover.

Vapour Stop of Valve (continued)



Figure 56:
Application of the flexible reinforcement membrane at spindle insulation termination

Apply and embed the flexible reinforcement membrane into the vapour stop.



Figure 57:
Application of vapour stop at spindle insulation termination

Smoothen the vapour stop to an even film thickness using the appropriate tools.

Allow the vapour stop coating to touch dry before applying additional coats. Continue to apply additional coats until the vapour stop has reached a film thickness specified by the manufacturer.

Application Details

Vapour seal – rigid pipe supports/insulation transition

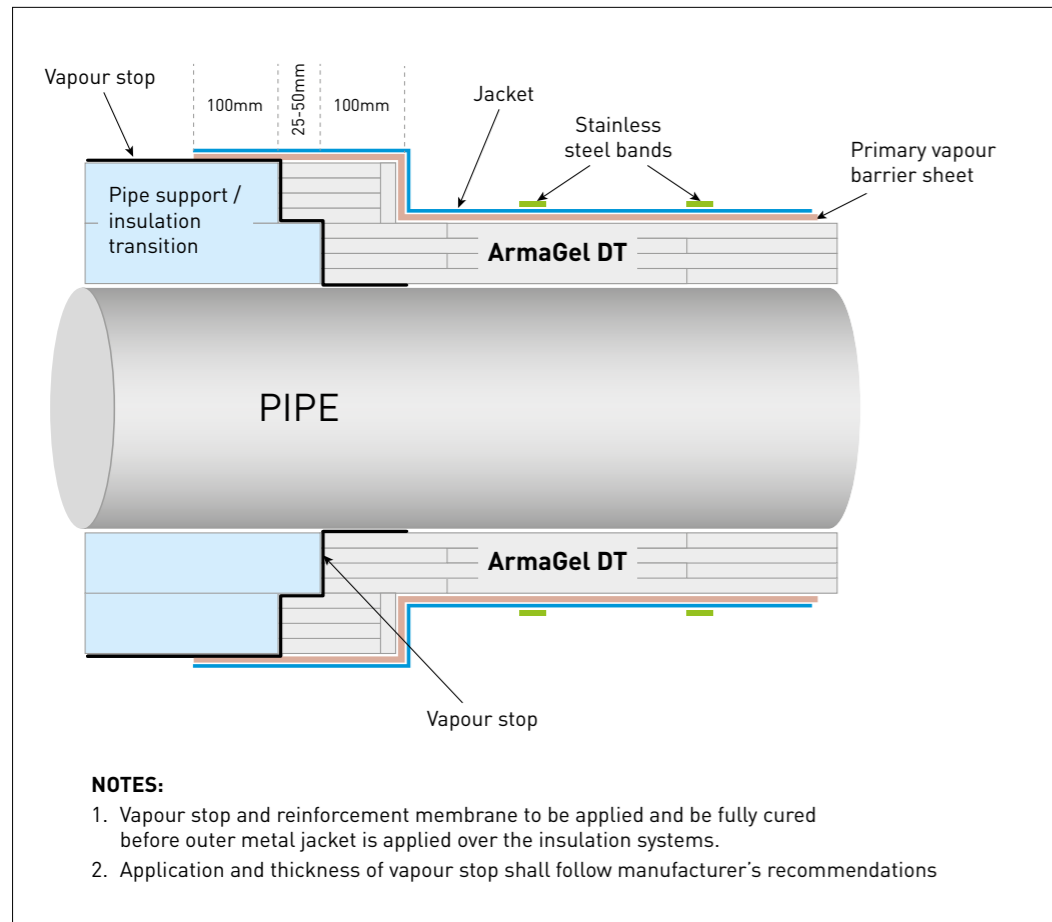

Figure 58:
Vapour stop at pipe support or insulation transition

Ensure that ArmaGel DT is tightly butted to the surface of the pipe support or insulation transition.

Clean away dust from the surface of the insulation and from the pipe support termination using a clean, dry cloth.

Apply a thick even coat of the vapour stop coating to the surfaces of the ArmaGel DT and the pipe support or insulation transition areas.

Embed the flexible reinforcement membrane into the vapour stop, and allow to touch dry.

Allow vapour stop coating to touch dry before applying the next coat. "Continue to apply additional layers until the vapour stop has reached a film thickness specified by the manufacturer".

Application Details

The butyl foil faced vapour barrier acts as a primary vapour barrier and provides certain degree of both mechanical / puncture protection during the installation of metal jacket.

Primary Vapour Barrier - Straights

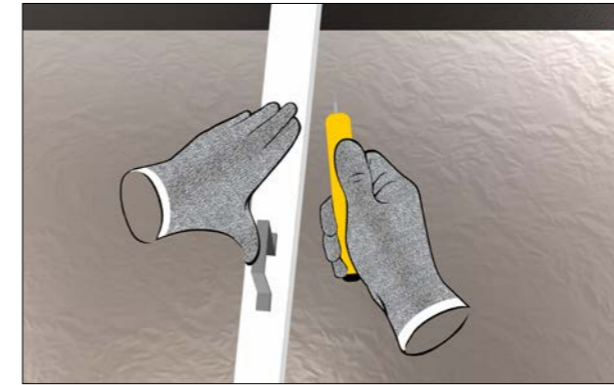

Figure 59:
Cutting butyl foil faced vapour barrier

Primary vapour barrier – 1.2mm thick self adhering butyl foil faced vapour barrier sheet shall be applied on the final layer of ArmaGel DT before the installation of the cladding.

For straight sections, roll out the material on a clean, dry and flat even surface (work bench).

Measure the outer surface circumference of the insulated part – allowing a minimum of 50mm for the overlap in all directions.

Using a straight edge and a sharp retractable craft knife, cut the primary vapour barrier sheet to size.



Figure 60:
50mm overlap of butyl foil faced vapour barrier at joints

Clean the outer surface of ArmaGel DT with a clean, dry cloth to remove any dust before applying the primary vapour barrier sheet.

Remove the release liner from the back of the primary vapour barrier sheet and wrap it tightly around the insulated pipe. The overlap for longitudinal and circumferential joints shall be at minimum of 50mm.



Figure 61:
Overlap at longitudinal and circumferential joints

Application Details

Primary Vapour Barrier - Straights (continued)

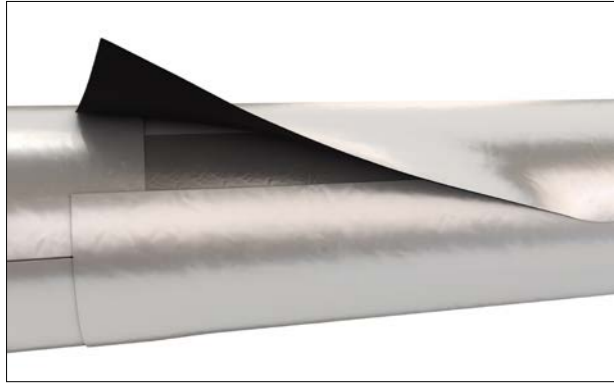

Figure 62:
Overlap to be fixed down firmly and creases can be removed by using a tape card

Creases can be removed by using a tape card. This ensures that the voids in the creases are fully bonded down to the substrate underneath.

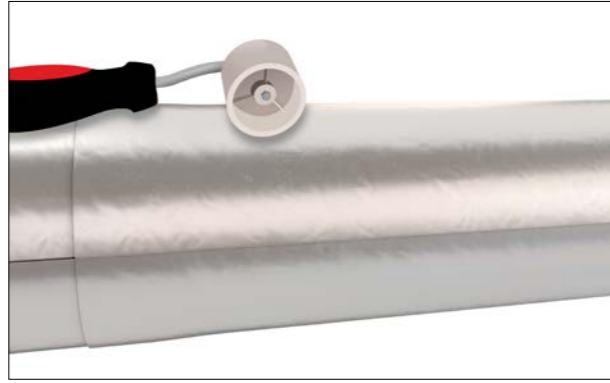

Figure 63:
Fixing seams with small plastic roller

The overlap is fixed with firm even pressure using a small plastic roller. Make sure the contacting area of the overlap is clean, dry and free from dust.

Longitudinal overlaps should be positioned to the side with the seams downward facing to provide a watershed.

Application Details

Primary Vapour Barrier – Bend

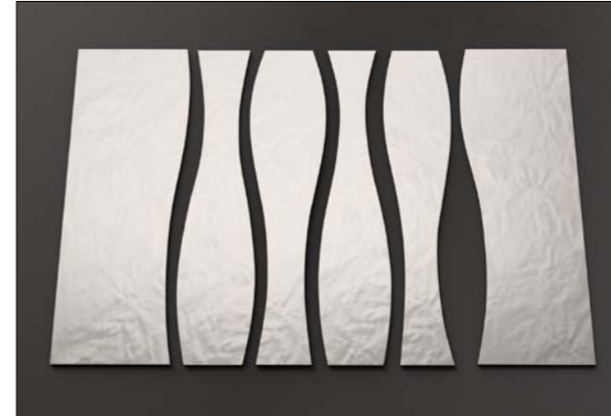

Figure 64:
Primary Vapour Barrier Segments

Fabricate the appropriate fishtail pattern from metal. The segments are fabricated to include for a 50mm longitudinal overlap and 10mm circumferential overlap.

Using a sharp cutting tool such as a blade or knife, cut the appropriate number of segments to complete the bend.



Figure 65:
Application of the first bend segment

Start the installation of the primary vapour barrier by applying the starter segment. Fix and secure in the same way as the straight sections of material.

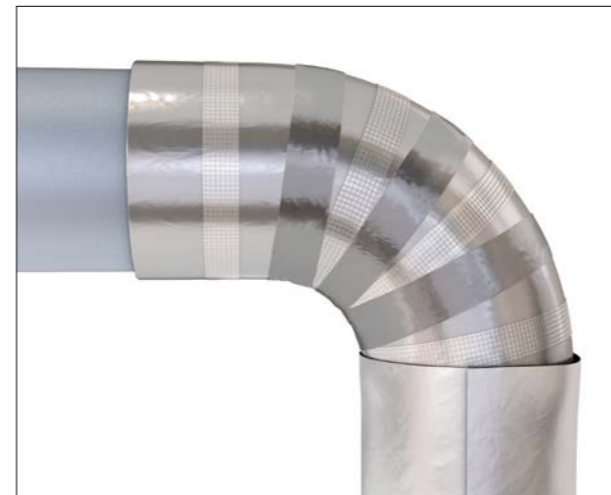

Figure 66:
Secure overlap with roller

Fix down the overlap (min. 50mm) with firm pressure using a roller.



Figure 67:
Application of primary vapour barrier segments

Apply the remaining centre segments.

Each segment should overlap around the circumferential edges by a minimum of 10mm.



Note

For vertical piping the circumferential overlap seams should always face downwards.

Application Details

Primary Vapour Barrier – Bend (continued)



Figure 68:
Applying last segment of primary vapour barrier

To complete the fitting, apply the final finishing segment.



Figure 69:
Securing overlaps with roller

Using a roller, apply even pressure to all of the overlap seams and joints. Ensure all overlaps are fully secured down without any gaps.

Application Details

Primary Vapour Barrier – Equal Tee



Figure 70:
Measuring equal tee

For the main body part of tee cut the primary vapour barrier to the required sizing - circumference and length of the body tee section as shown. Allowance for a 50mm overlap to be added.



Figure 72:
Application of primary vapour barrier on equal tee

Position the primary vapour barrier in the correct position ready for fixing down to the insulation surface.

Peel back the release paper of the primary vapour barrier and fix it to the insulation surface.

Continue the application of the primary vapour barrier in the same way as with the straight sections.

Creases and crinkles can be removed by using a tape card during the application. This ensures that the voids in the creases are fully bonded down to the substrate underneath.

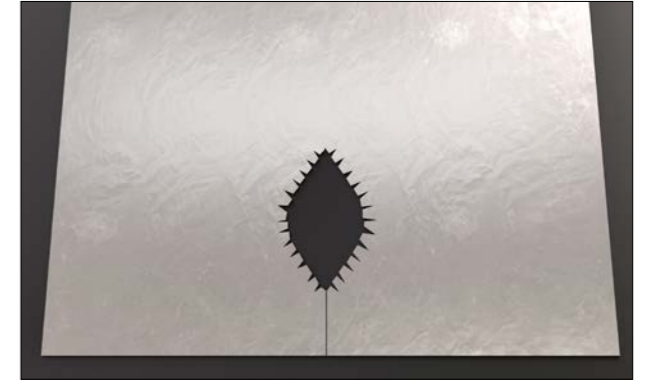

Figure 71:
Template of primary vapour barrier for equal tee

Depending on the positioning of the Tee, the longitudinal overlap shall be considered when fabricating the body tee section.

Make the cut outs for the diameter of the insulated pipe tee.

A metal template can be produced for multiple fittings.

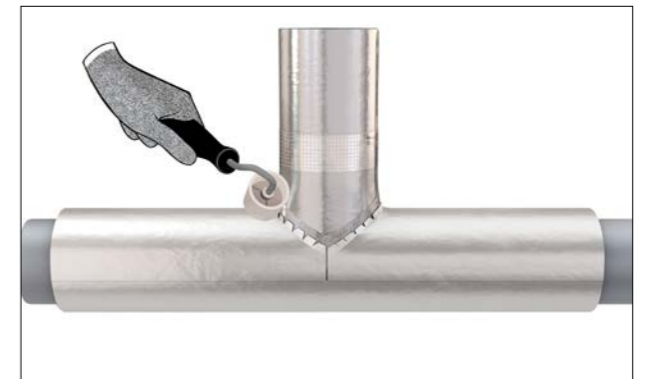

Figure 73:
Securing joints with roller

Using a roller, apply even pressure to all of the overlap seams and joints. Ensure all overlaps are fully secured down without any gaps.

Application Details

Primary Vapour Barrier – Equal Tee (continued)



Figure 74:
Determining the height of tee piece

Cut the primary vapour barrier to the appropriate size and shape.

Use the lengths L1 & L2 to create the size and shape of the required tee piece. Metal templates can be fabricated when preparing multiple tee pieces.



Figure 76:
Securing joints with roller

Using a roller, apply even pressure to all of the overlap seams and joints. Ensure all overlaps are fully secured down without any gaps.



Figure 75:
Application of primary vapour barrier on tee

Apply the primary vapour barrier similar to the method as for straight pipe.

Hot Insulation with Line Temperature from Ambient to 250 °C

For **hot insulation** with line temperature from ambient to +250 °C, glass reinforced filament tapes, stainless steel wire with diameter of 1mm, or stainless steel bands with 19mm wide x 0.5mm thick can be used to secure the insulation layer(s).

Glass reinforced filament tapes shall not be used for the securement of insulation layer(s) with interface temperature above 70 °C unless otherwise specified by Project Insulation Specification or Project Engineer.

The seams and joints of insulation do not require sealing with the vapour barrier tape unless otherwise specified by the projects insulation specification or project engineer.

No additional primary vapour barrier is required for the construction of the insulation systems.

No vapour stop is required for the construction of the insulation systems.



Note

Ambient temperature refers to the maximum summer high temperature at the facility location/site of the project.

Dual-temperature Insulation with Line Temperature from -40 °C to 250 °C

For **dual-temperature insulation** with line temperature operating in cyclic mode from -40 °C to +250 °C, glass reinforced filament tapes, or stainless steel bands with 19mm wide x 0.5mm thick can be used to secure the insulation layer(s).

Glass reinforced filament tapes shall not be used for the securement of insulation layer(s) with interface temperature above 70 °C unless otherwise specified by Project Insulation Specification or Project Engineer.

Only seams and joints of the last layer of ArmaGel DT shall be sealed with vapour barrier tape unless otherwise specified by the Projects Insulation Specification or Project Engineer.

The primary vapour barrier sheets shall be applied over the last layer of ArmaGel DT prior to the installation of the outer jacketing (metal / UVGRP cladding) unless otherwise specified by the project insulation specification or Project Engineer.

Refer to Project Insulation Specification or Project Engineer for the needs and the construction details of vapour stop.

Jacketing and Finishing

Jacketing and Finishing

Allow the vapour stop coating to fully dry before applying the outer jacketing.

In all industrial applications, ArmaGel DT must be protected with an adequate jacketing. ArmaGel DT is compatible with all forms of jacketing such as metal cladding, polymeric covering (such as Arma-Chek R), GRP and multi-ply laminate cladding system.

The outer cladding should always be applied according to manufacturer's instructions and in accordance with the site/project insulation specification.

Screws and rivets shall be avoided wherever possible unless absolutely necessary.

Standoffs or a sacrificial layer using closed cell foam materials shall be applied if screws or rivets are necessary to be used to secure the metal cladding in order not to puncture the primary vapour barrier. The thickness of sacrificial layer or standoff shall be higher than the length of the rivet/screw used.

Care shall be taken not to damage the insulation system during installation of the rigid jacket.



Note

Ambient temperature refers to the maximum summer high temperature at the facility location/site of the project.

Insulation and Accessory Materials List

System Component & Suggested Products	Material Description	Areas of Use
Insulation <ul style="list-style-type: none"> ArmaGel DT 5mm sheet ArmaGel DT 10mm sheet ArmaGel DT 15mm sheet ArmaGel DT 20mm sheet 	<ul style="list-style-type: none"> Dual temperature aerogel insulation blanket of 5mm thickness Dual temperature aerogel insulation blanket of 10mm thickness Dual temperature aerogel insulation blanket of 15mm thickness Dual temperature aerogel insulation blanket of 20mm thickness 	Used as insulation material for cryogenic and/or dual-temperature (cyclic) conditions from -180 to 250 °C.
Primary vapour barrier - Foil faced butyl sheet <ul style="list-style-type: none"> Polyguard / Insulrap 50 Sam Hwa – BUSEAL WRAP 12 Foster C.I. Wrap 50 STI – STI 5000 Temati - Tembutil-IF 	A self adhesive 1.0 – 1.2mm thick , vulcanising butyl rubber sheeting wrap, at one side backed with a multiplex foil, as per project/site requirement.	Used as primary vapour barrier. Applied on the outer surface of last layer of ArmaGel DT insulation, prior to the fitting of metal cladding.
Vapour barrier tape <ul style="list-style-type: none"> Venture Tape - 1517CW Temati - VaporStop Foil/Tape Venture Tape - 1555 CW 	Aluminium foil, or multiply of aluminium and polyester film provided on one side with an adhesive layer on the basis of synthetic rubber and synthetic resin, and covered with a protective foil. The compatibility between the foil tape and primary vapour barrier should be checked.	For the sealing of all seams and joints of ArmaGel DT insulation where the surface temperature is not lower than -40°C.
Vapour barrier tape <ul style="list-style-type: none"> Polyken 360-17 Venture Mastik tape 1580 	A self adhesive 0.5 - 1.0 mm thick , vulcanising butyl rubber mastic adhesive tape, at one side backed with a multiplex foil.	For the sealing of all seams and joints of ArmaGel DT insulation where surface temperature is below -40°C.
Vapour stop <ul style="list-style-type: none"> Foster 60-38/39* Foster 60-95/96* Foster 90-66** Foster 90-61** Sam Hwa SHC 107-61** 	Elastomer based vapour stop sealant - to be used with the flexible reinforcement membrane.	Used as vapour stop sealant for insulation terminations next to flanged fittings, cap ends, protrusions, valve and flange and etc. *Used for service temperature down to -40 °C. ** Used for service temperature down to -196 °C

Insulation and Accessory Materials List (continued)

System Component & Suggested Products	Material Description	Areas of Use
Flexible Reinforcement Membrane <ul style="list-style-type: none"> Mast –A– Fab 42-22. Chil-Glas Scrimtex (N 10) 	Woven glass scrim reinforced chlorosulfonated polyethylene (CSPE) membrane or similar polymeric compound materials.	Used as reinforcement membrane for the construction of vapour stop.
Self-Adhesive synthetic (Filament) tape <ul style="list-style-type: none"> Scotch 893 	Glass fibre-reinforced synthetic tape 25, 40 & 50mm wide.	Used to secure ArmaGel DT insulation layers around piping and applicable fittings.

All data and technical information are based on results achieved under the specific conditions defined according to the testing standards referenced. Despite taking every precaution to ensure that said data and technical information are up to date, Armacell does not make any representation or warranty, express or implied, as to the accuracy, content or completeness of said data and technical information. Armacell also does not assume any liability towards any person resulting from the use of said data or technical information. Armacell reserves the right to revoke, modify or amend this document at any moment. It is the customer's responsibility to verify if the product is suitable for the intended application. The responsibility for professional and correct installation and compliance with relevant building regulations lies with the customer. This document does not constitute nor is part of a legal offer to sell or to contract.

At Armacell, your trust means everything to us, so we want to let you know your rights and make it easier for you to understand what information we collect and why we collect it. If you would like to find out about our processing of your data, please visit our Data Protection Policy.

© Armacell, 2022. ArmaGel® is a trademark of the Armacell Group and is registered in the European Union and other countries.
00006 | ArmaGel DT | ArmaGel I InstManual | 022022 | Global | EN MASTER

ABOUT ARMACELL

As the inventors of flexible foam for equipment insulation and a leading provider of engineered foams, Armacell develops innovative and safe thermal, acoustic and mechanical solutions that create sustainable value for its customers. Armacell's products significantly contribute to global energy efficiency making a difference around the world every day. With 3,000 employees and 23 production plants in 15 countries, the company operates two main businesses, Advanced Insulation and Engineered Foams. Armacell focuses on insulation materials for technical equipment, high-performance foams for high-tech and lightweight applications and next generation aerogel blanket technology.

For more information, please visit:
www.armacell.com/armagel

